

NGS - variant analysis

Introduction to variant analysis

Why study variants?

- Find causes for phenotypic variation
- Understand relatedness

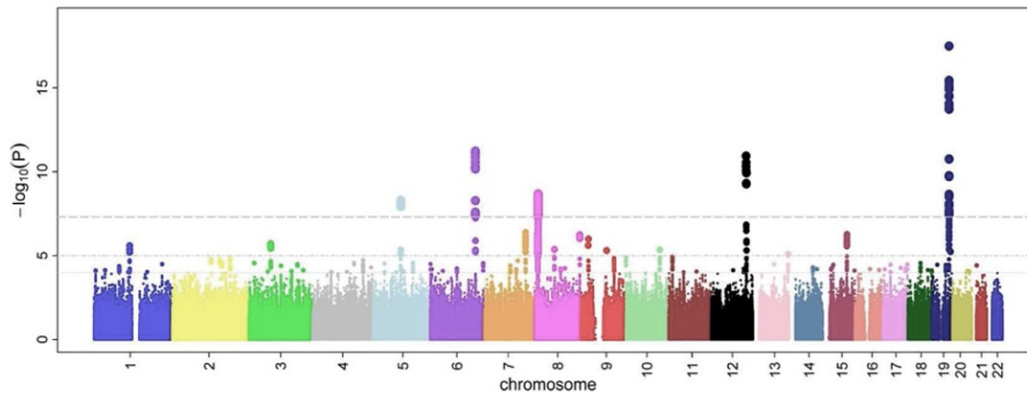

https://en.wikipedia.org/wiki/Genome-wide_association_study

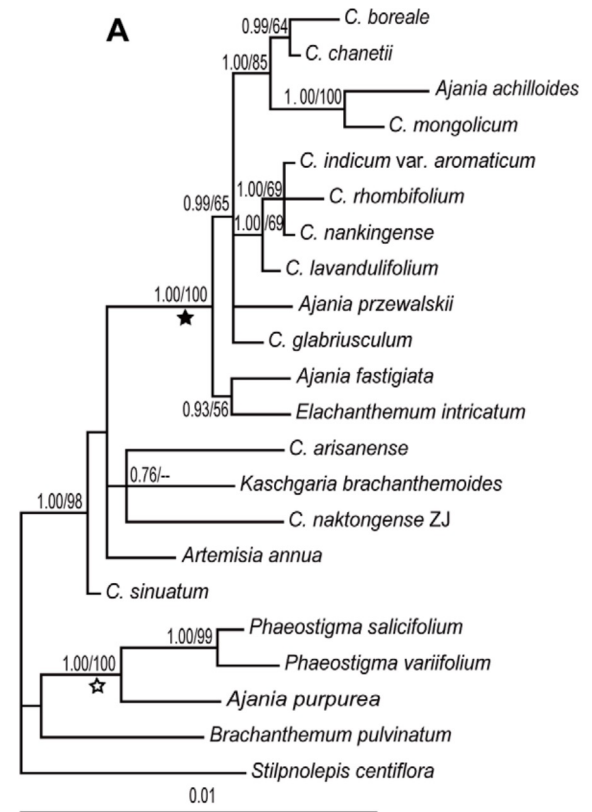

Mutation

Causes variation

Change in DNA sequence

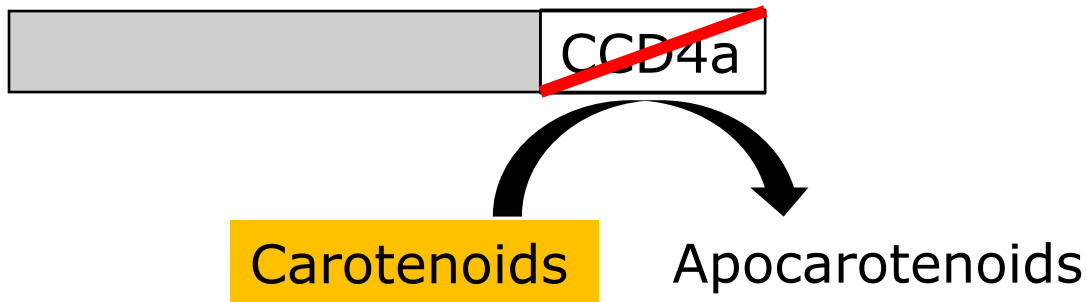

Mutations - causes

- Repair mistakes
- Unbalanced cell division
- Transposable elements



https://nl.wikipedia.org/wiki/Springend_gen

Mutations - types

- inherited – germline mutation
- cells – somatic mutation

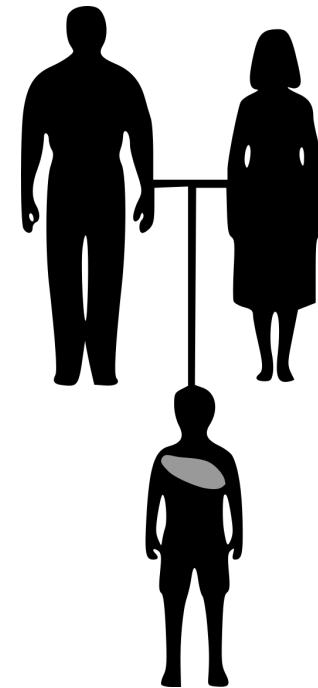
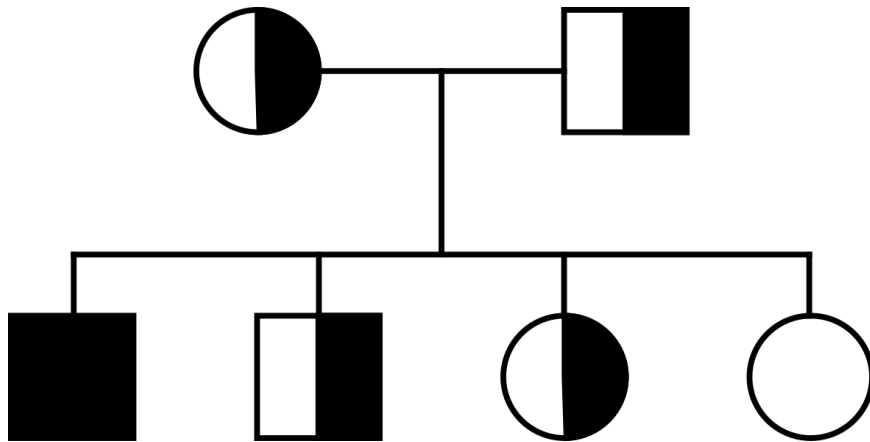



Quiz Question 4

Detecting variants

- Phenotypic analysis
- Molecular analysis
 - Sequencing

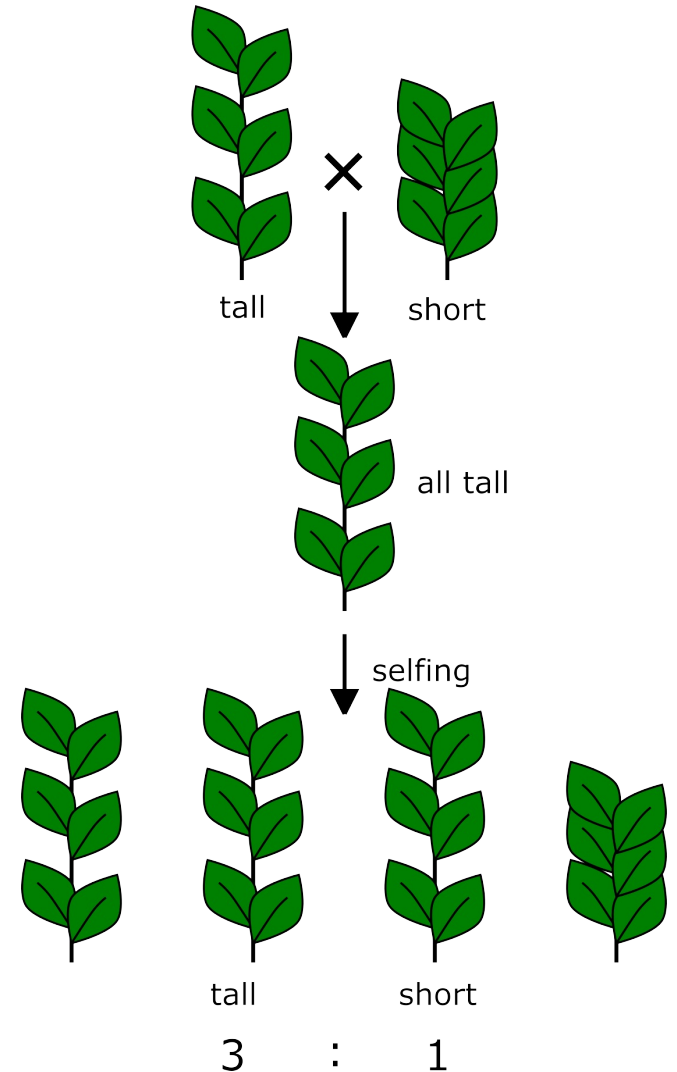
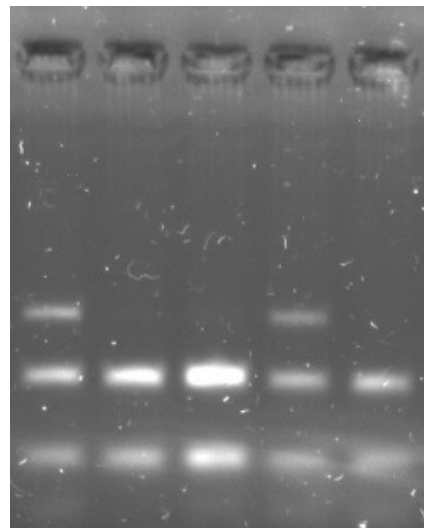
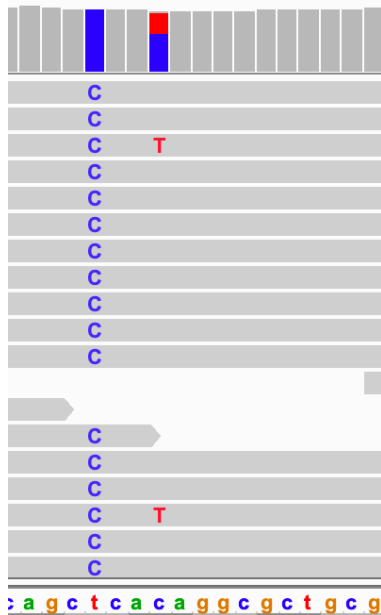

Small variants

- Single nucleotide variant (SNV)

ATCATG**A**CCGTCA
ATCATG**T**CCGTCA

- Insertion/deletion (INDEL)

ATCATG**ACC**GTCA
ATCATG**- - -**GTCA

Some definitions..

- **Variant:** any difference that exists between any DNA
- **Mutation:** a change in DNA
- **Polymorphism:** variation that is common in a population (often AF > 1%)

Variant vs polymorphism can be problematic: depends on the population

Haplotypes

- NGS variants: mostly SNP
- Most SNPs are bi-allelic e.g. [A/T], [G/C]
- Genetic variation is often multi-allelic

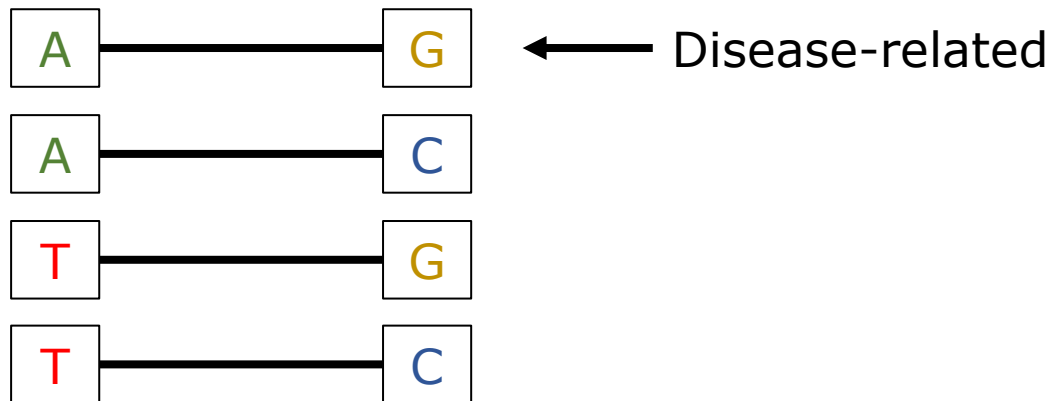

Quiz Question 5

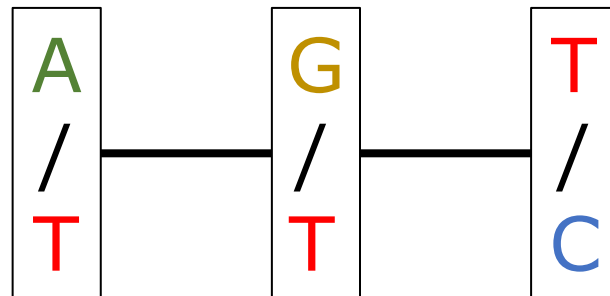

Large variants

- Structural variance ($> 1,000$ base pairs)
 - Copy number variation
 - Translocations
 - Inversions
 - Deletions/insertions
- Chromosomal aberration

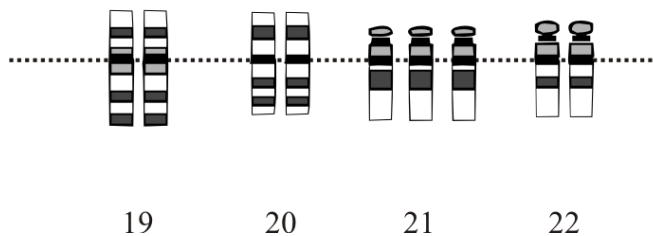

<https://en.wikipedia.org/wiki/Aneuploidy>



Genetic association

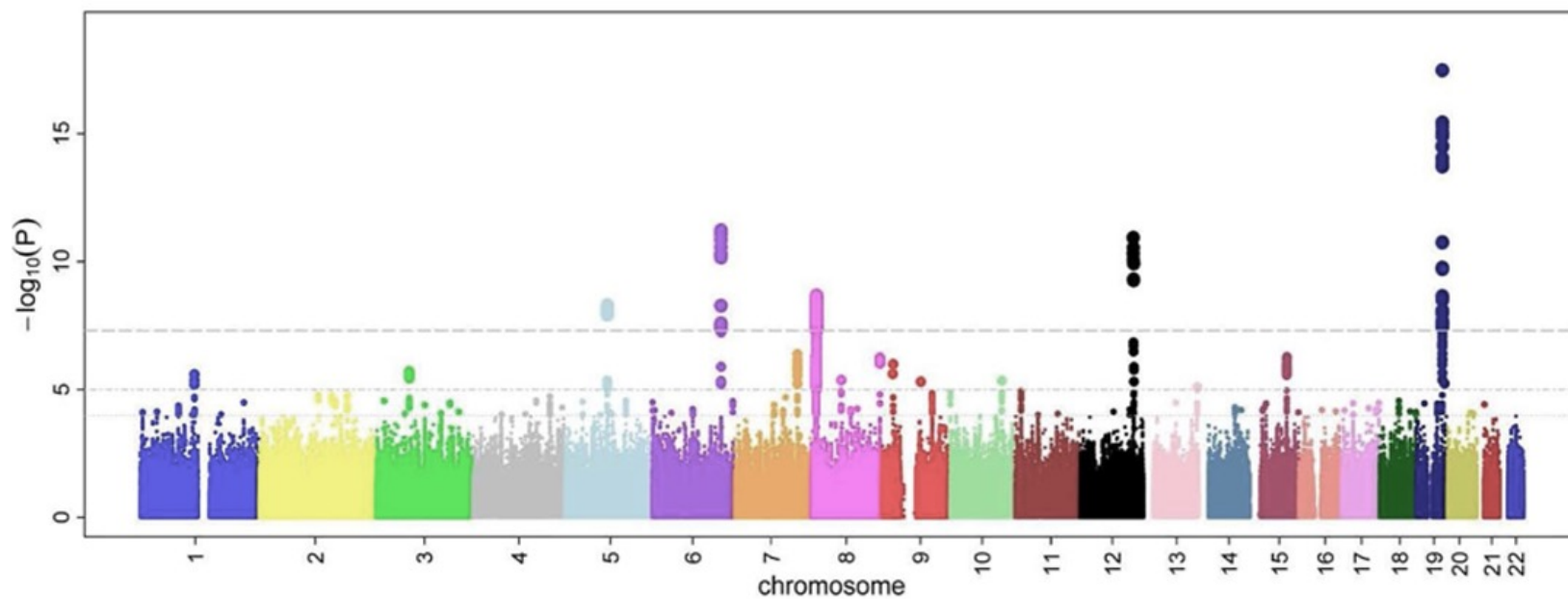

https://en.wikipedia.org/wiki/Genome-wide_association_study

Relatedness

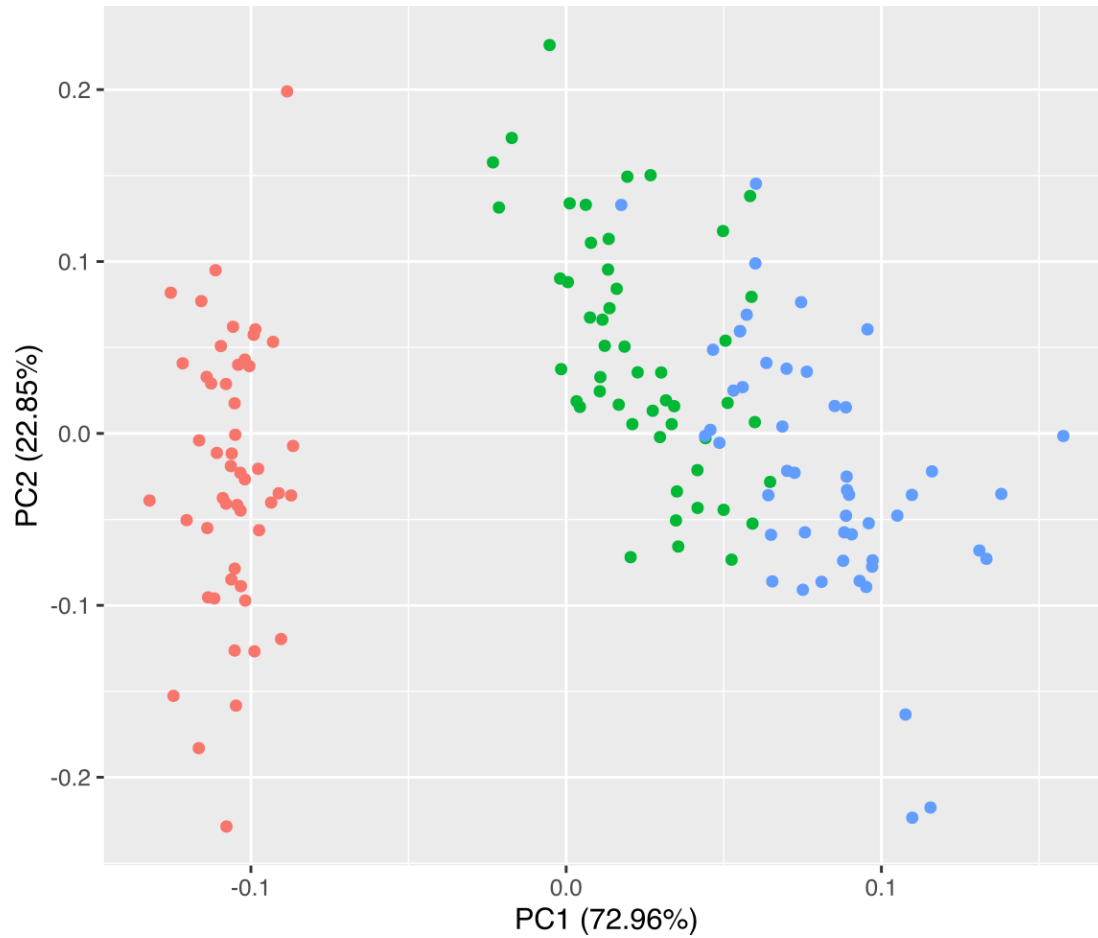

This course

- Inherited (germline) small variants
- Detection by next generation sequencing (NGS)

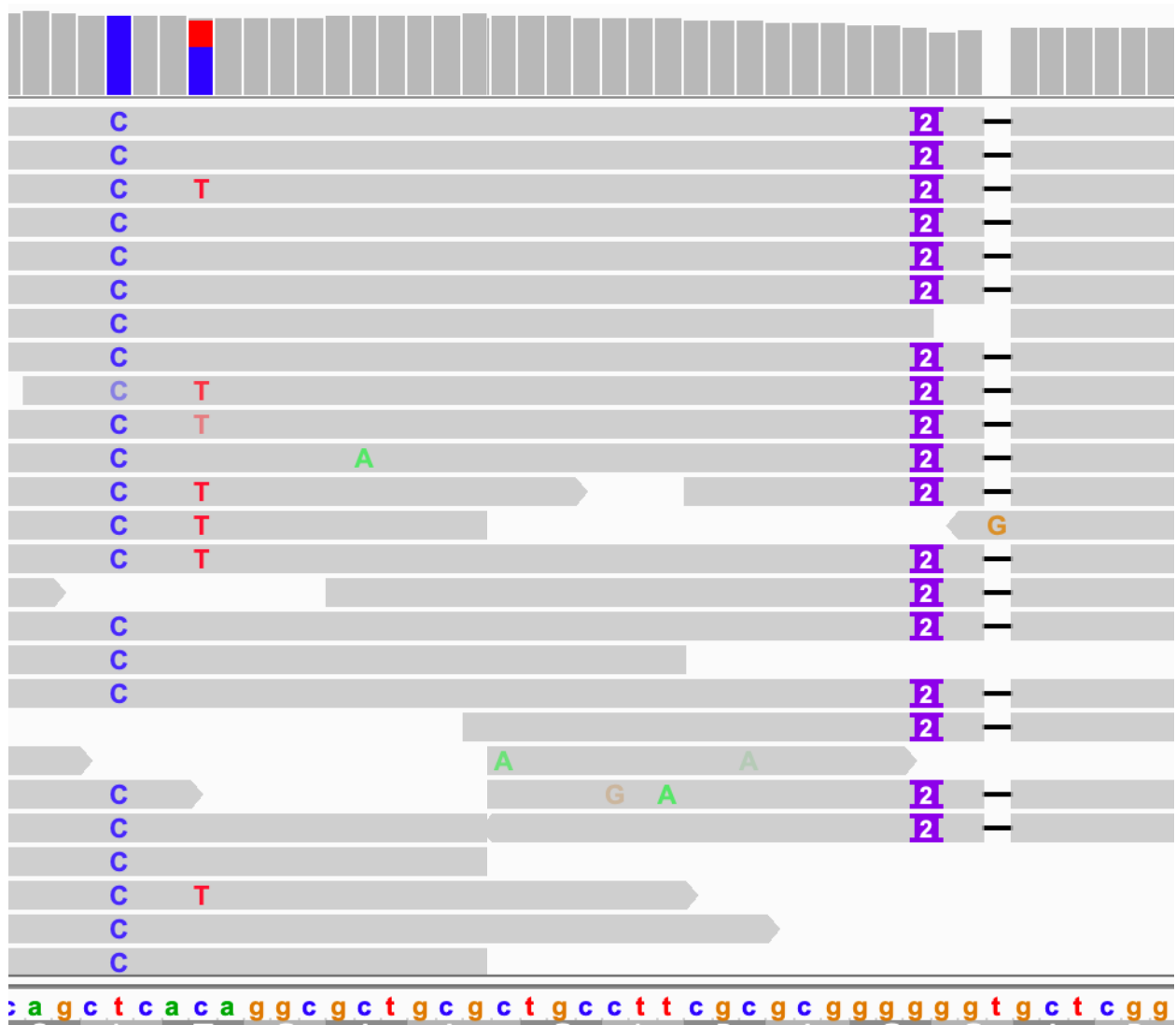

GATK

